



# The End of Warm Water Cooling.....

**Michael K Patterson, PhD, PE**

**Systems Architecture and Pathfinding**

**Technical Computing Group**

**June 5, 2014**

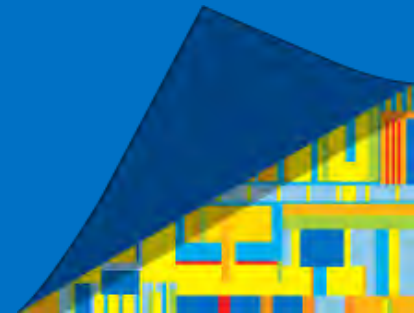

# Agenda

- Why Liquid
- What is Liquid Cooling?
- ASHRAE Guidelines
- Warm water cooling
- Cooling system considerations
- Water Quality
- References & Resources
- Summary

# Why Liquid?

## **Warm water cools better than cold air**

- better thermal properties
- liquid can get physically and thermally closer to the heat source

## **Water is “smaller” than air**

- same volume of water cools much better than the same volume of air
- *this matters....* Thermal challenges going forward are really as much about rack level volumetric challenges as they are about heat flux from a piece of silicon

# Liquid cooling may offer...

- Lower component temperature
- Reduced silicon leakage
- Lower energy use
- Higher clock speeds
- Better stability
- Faster time to solution
- Higher density (important for HPC)
- Better reliability
- Reduced TCO
- Energy recovery opportunity
- Higher rack power density in legacy data centers

# Which is liquid cooling? A or B?

a)



b)

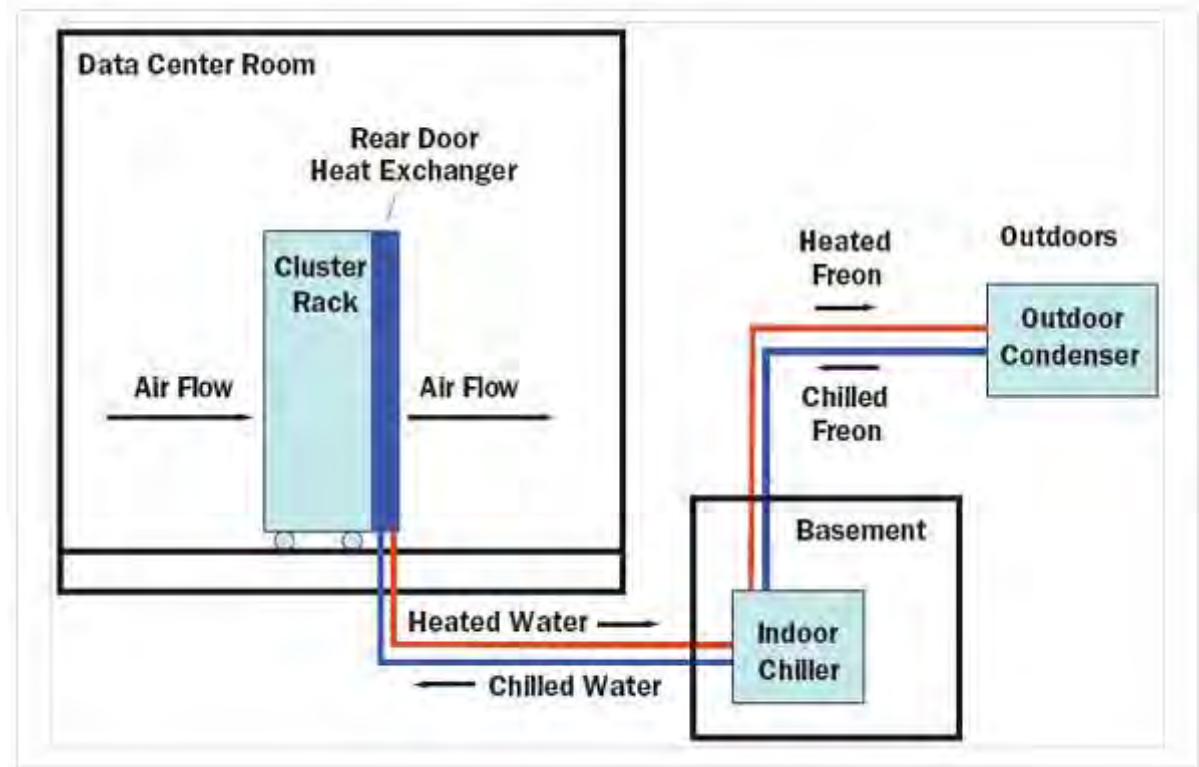

From: <http://www.electronics-cooling.com/2006/11/liquid-cooling-of-a-high-density-computer-cluster/>

# Which is liquid cooling?

1) A, not B

the laptop (a) has a heat pipe that moves heat in a liquid from the CPU to the atmosphere, the rack (b) CPUs have cool air blowing across a heat sink

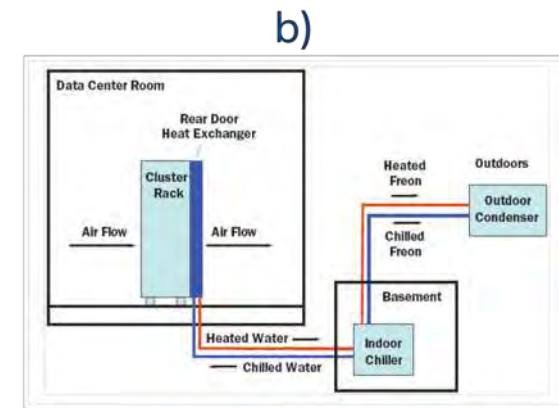

From: <http://www.electronics-cooling.com/2006/11/liquid-cooling-of-a-high-density-computer-cluster/>

2) B, not A

the laptop (a) doesn't need to be connected, the rack (b) took a lot of plumbing to make this work

3) Neither

none of the compute hardware has a liquid cold plate and loop to take heat outside the platform "box"

4) Both

the laptop and the rack take advantage of liquid thermo-physical properties to enhance the thermal performance

All are correct! It depends on your perspective

# System Definitions – all different, all about how close the liquid gets to the components

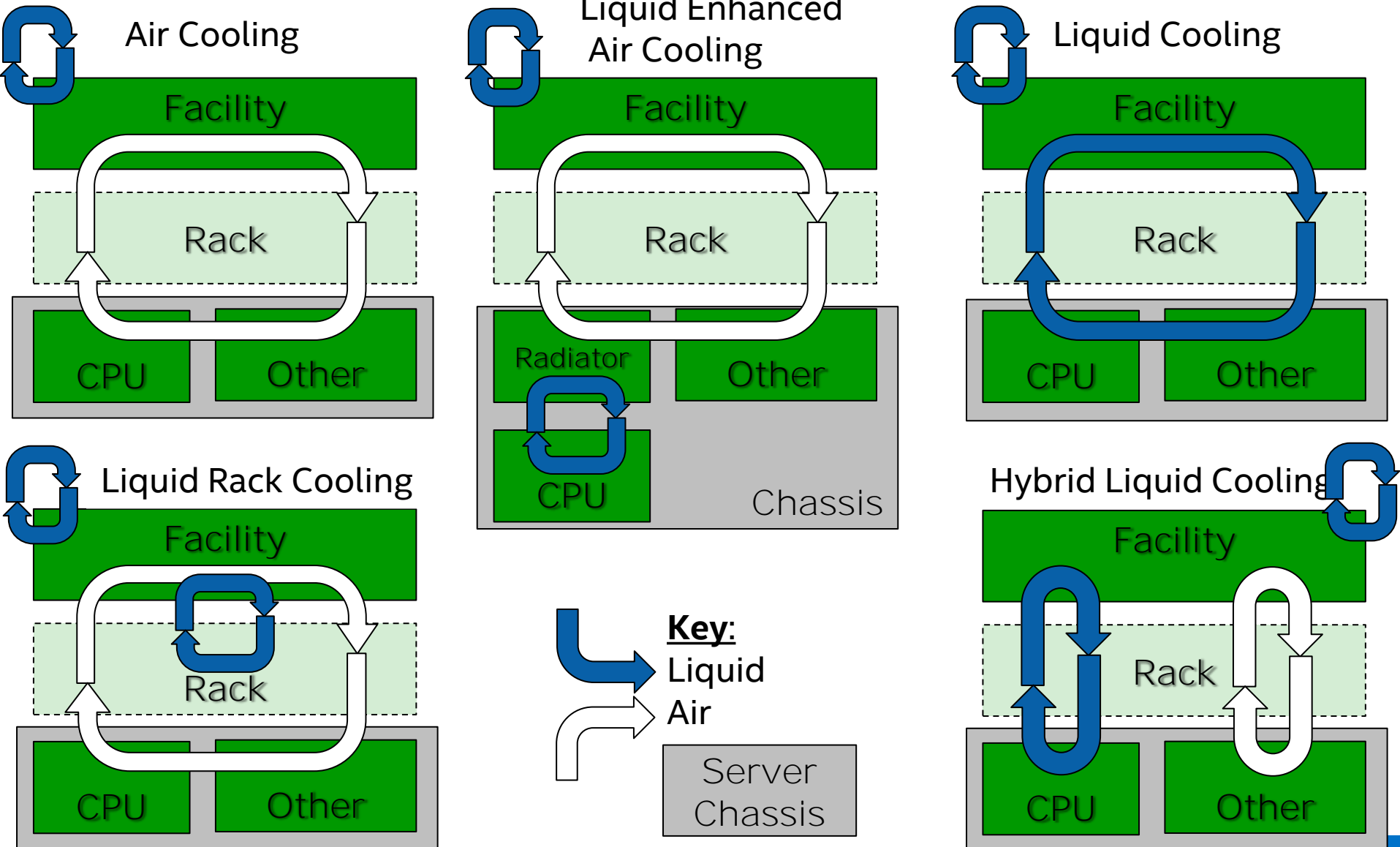

# ASHRAE Liquid Cooling Guidelines

- ASHRAE team worked to provide better guidance for liquid cooled systems
- Bull, Cray, Dell, HP, IBM, Intel, SGI, and others all participated
- Download at:
- <http://tc99.ashraetcs.org/>

ASHRAE TC 9.9

## **2011 Thermal Guidelines for Liquid Cooled Data Processing Environments**

Whitepaper prepared by ASHRAE Technical Committee (TC) 9.9 Mission Critical Facilities, Technology Spaces, and Electronic Equipment

© 2011, American Society of Heating, Refrigerating and Air-Conditioning Engineers, Inc. All rights reserved. This publication may not be reproduced in whole or in part; may not be distributed in paper or digital form; and may not be posted in any form on the Internet without ASHRAE's expressed written permission. Inquiries for use should be directed to [publisher@ashrae.org](mailto:publisher@ashrae.org)



# White paper highlights

- Introduction and guidance for new construction, expansions, HPC focus
- Interface definitions, how and where do we specify the liquid
- Liquid cooling classes; W1-W5
- Design and operational considerations; condensation, flow & pressure, water quality and water treatment, materials and connections, references and bibliography
- US National Labs liquid cooling efforts

# Liquid Cooling Guidelines for Datacom Equipment Centers

ASHRAE Datacom Series

4



American Society of Heating, Refrigerating and Air-Conditioning Engineers, Inc.

The White Paper has been incorporated into the 2<sup>nd</sup> Edition.

Tip: 2<sup>nd</sup> Edition just published, not yet available on ASHRAE web site. Keep checking back... wait for 2<sup>nd</sup> edition to buy!

# 2011 ASHRAE Liquid-Cooled Thermal Guidelines

Classes	Typical Infrastructure Design		Facility Supply Water Temp (C)	IT Equipment Availability
	Main Cooling Equipment	Supplemental Cooling Equipment		
W1	Chiller/Cooling Tower	Water-side Economizer Chiller	2 – 17	Now available
W2			2 – 27	
W3	Cooling Tower	Chiller	2 – 32	Becoming available, dependent on future demand
W4	Water-side Economizer (with drycooler or cooling tower)	Nothing	2 – 45	
W5	Building Heating System	Cooling Tower	> 45	Not for HPC

***Required Cooling Infrastructure: Balance of Silicon/Datacenter***

# Warm water cooling

If we struggle defining liquid cooling, why do we expect to be able to define warm water cooling?

Google search for **warm water cooling HPC** yields 1,080,000 results

Bing search for **warm water cooling data center** yields 45,000,000 results

Yahoo search for **“warm water cooling”** yields 22,000 results

Warm water cooling is good news / big news

# But what does *Warm* mean?

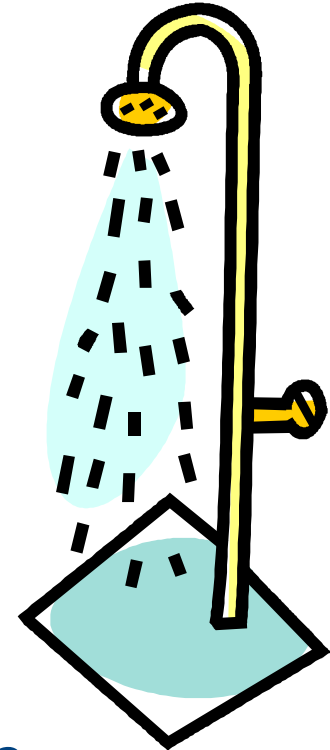
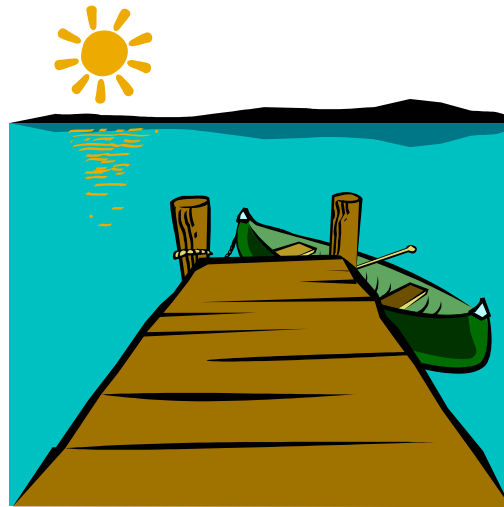
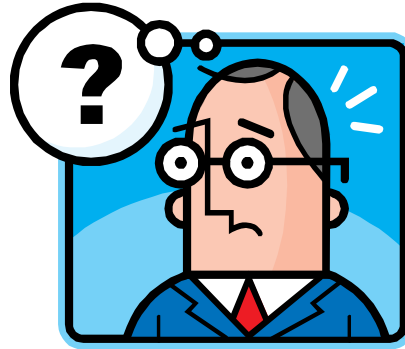

W1

17C  
63F

W2

27C  
81F

W3

32C  
90F

W4

45C  
113F

Not to scale

*Just say no....*

# Warm Water Cooling



*Instead, define either specific temperatures or functional....*

Define the temperature at  
the facilities and IT water  
loop interface

**W2, W3, W4**

Define how the water  
temperature is made

**Chiller**

**Cooling Tower**

**Dry Cooler**

# Geo-dependent functional description

(instead of “warm-water cooling, define the cooling system)

Cooling loops provide different temperatures depending on where you are:

**Dry coolers** approach ambient outdoor dry-bulb temperature for the theoretical limit

**Cooling towers** approach ambient outdoor wet-bulb temperature for the theoretical limit

**Chillers** can provide cooler water with higher CapEx and OpEx, needed for W1 or W2 in most all environments, needed for W3 in some environments

Approach temperatures (how close to theoretical) are a trade-off CapEx vs OpEx

# ASHRAE WP cooling loop block diagrams

Figure 3a. Class W1/W2/W3

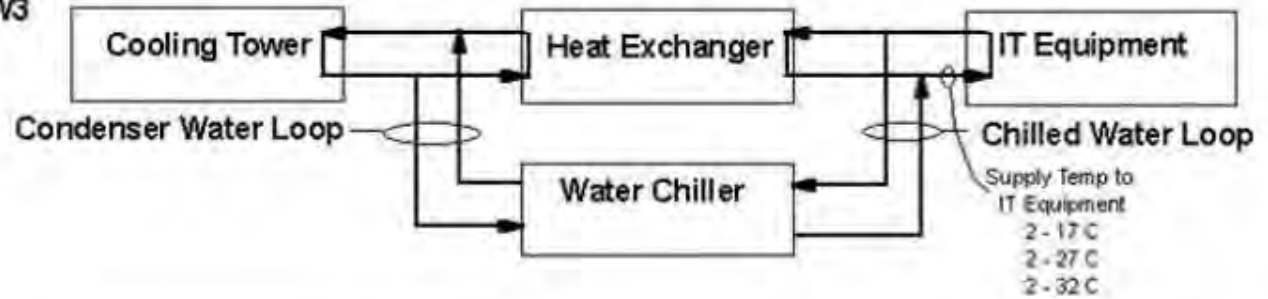

Figure 3b. Class W4

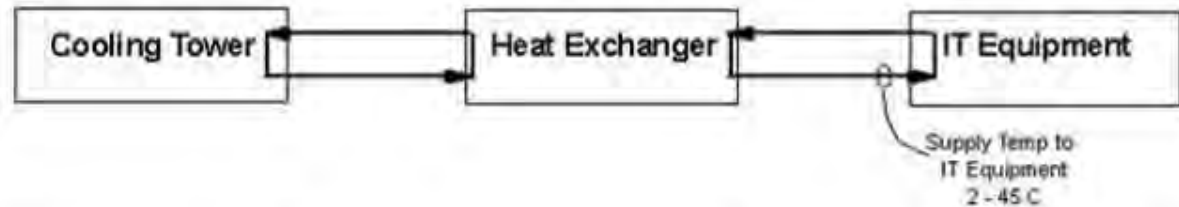

Figure 3c. Class W5

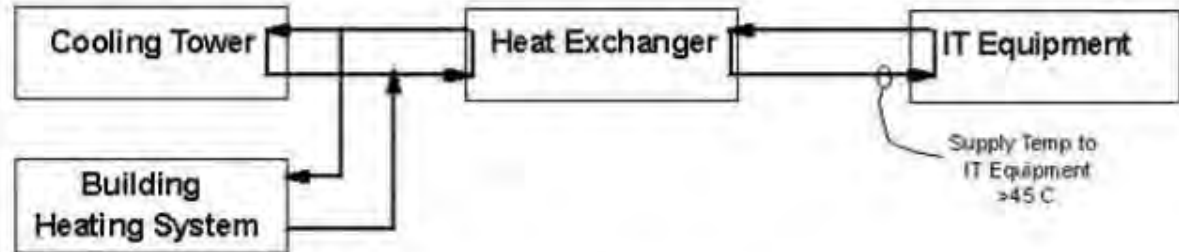

Figure 3a,b,c: Class W1 / W2 / W3, Class W4, Class W5

**These are typical, NOT required! NREL can make W2 with just a cooling tower**



# US DOE National Labs (plus Houston)

HPC Data Center Owner	U.S. State	City Name	Close Location Available in ASHRAE Database	Dry Cooling Dry Bulb 0.4% Design Temperature		Evap. Cooling Wet Bulb 0.4% Design Temperature	
				°F	°C	°F	°C
Houston Texas	Texas	Houston	Bush Intl. Apt.	96.8	36.0	80.1	26.7
Jefferson Laboratory	Virginia	Newport News	New Port News	94.5	34.7	79.7	26.5
Ames National Laboratory	Iowa	Ames	Ames Muni Apt	90.5	32.5	79.2	26.2
Princeton Plasma Physics Laboratory	Princeton	New Jersey	Mcguire AFB	92.9	33.8	78.8	26.0
Oak Ridge National Laboratory	Tennessee	Oak Ridge	Nashville Intl Apt	94.4	34.7	78.2	25.7
Argonne National Laboratory	Illinois	Argonne	Chicago Midway Apt	92.1	33.4	78.0	25.6
Fermilab	Illinois	Batavia	Aurora Municipal Apt	90.8	32.7	77.7	25.4
Brookhaven National Laboratory	New York	Upton	Long Island Macarthur Apt	88.4	31.3	76.7	24.8
Pacific Northwest National Laboratory	Washington	Richland	Pasco	99.5	37.5	72.1	22.3
Lawrence Livermore National Laboratory	California	Livermore	Livermore Municipal Apt	98.8	37.1	70.8	21.6
Stanford Linear Accelerator Center	California	Menlo Park	San Jose Intl Apt	92.3	33.5	69.5	20.8
Lawrence Berkeley National Laboratory	California	Berkeley	Oakland	81.8	27.7	67.6	19.8
Los Alamos National Laboratory	New Mexico	Los Alamos	Albuquerque Intl Apt	95.2	35.1	65.3	18.5
Sandia National Laboratory	New Mexico	Albuquerque	Albuquerque Intl Apt	95.2	35.1	65.3	18.5
Idaho National Laboratory	Idaho Falls	Idaho	Fanning Field Apt	91.7	33.2	64.9	18.3
National Renewable Energy Laboratory	Colorado	Golden	Denver Stapleton Intl Apt	93.5	34.2	64.4	18.0

W3 defined by the 99.6% design point for 32C facilities water



## Estimate of Air-side Economizer Hours for ASHRAE 2011 Class A2 Data Centers

© 2012 The Green Grid

Number of hours where:

Drybulb Temp  $\leq$  35C  
Dewpoint Temp  $\leq$  21C

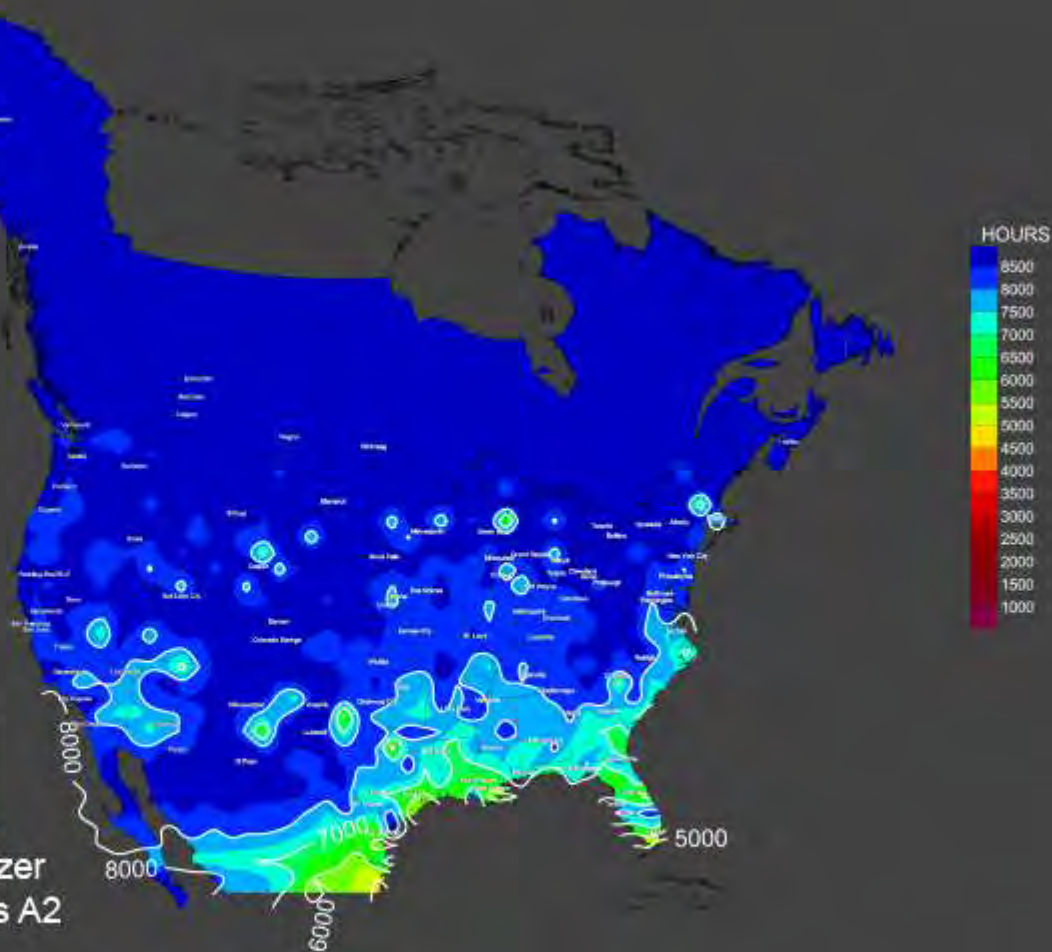

**Similar to airflow (defined at the IT inlet), liquid is defined as the interface between facilities and IT**

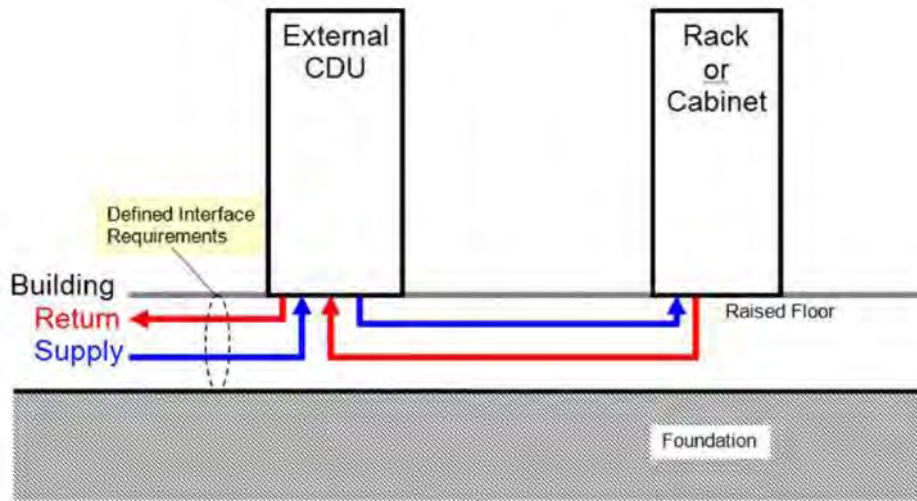

*Figure 1: Combination air- and liquid-cooled rack or cabinet with external CDU*

**W1 thru W5 is defined at the IT and Facilities interface**

# Water Quality - #1 Challenge

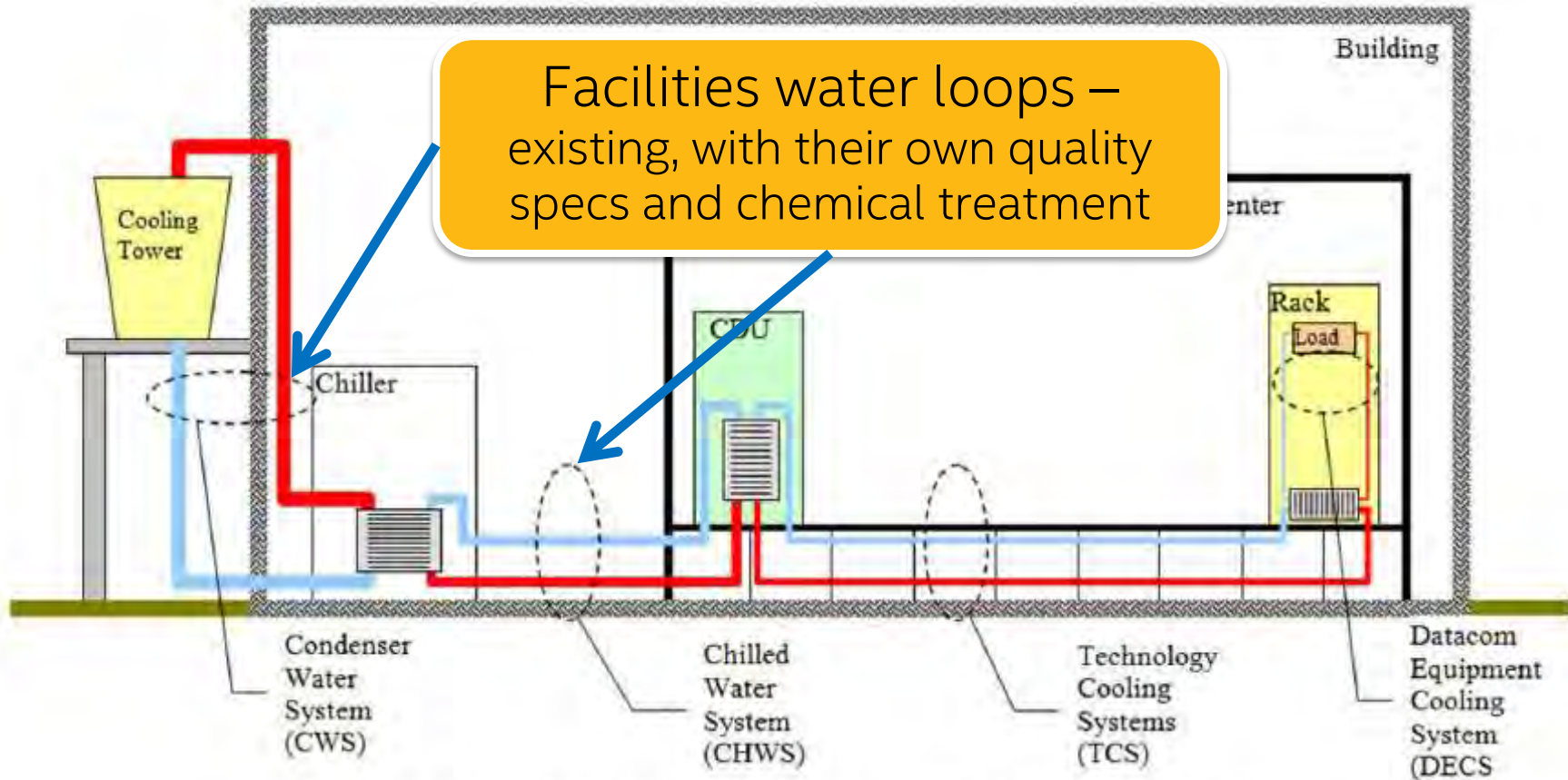

Figure 3: Liquid Cooling Systems / Loops within a Data Center

# Water Quality - #1 Challenge

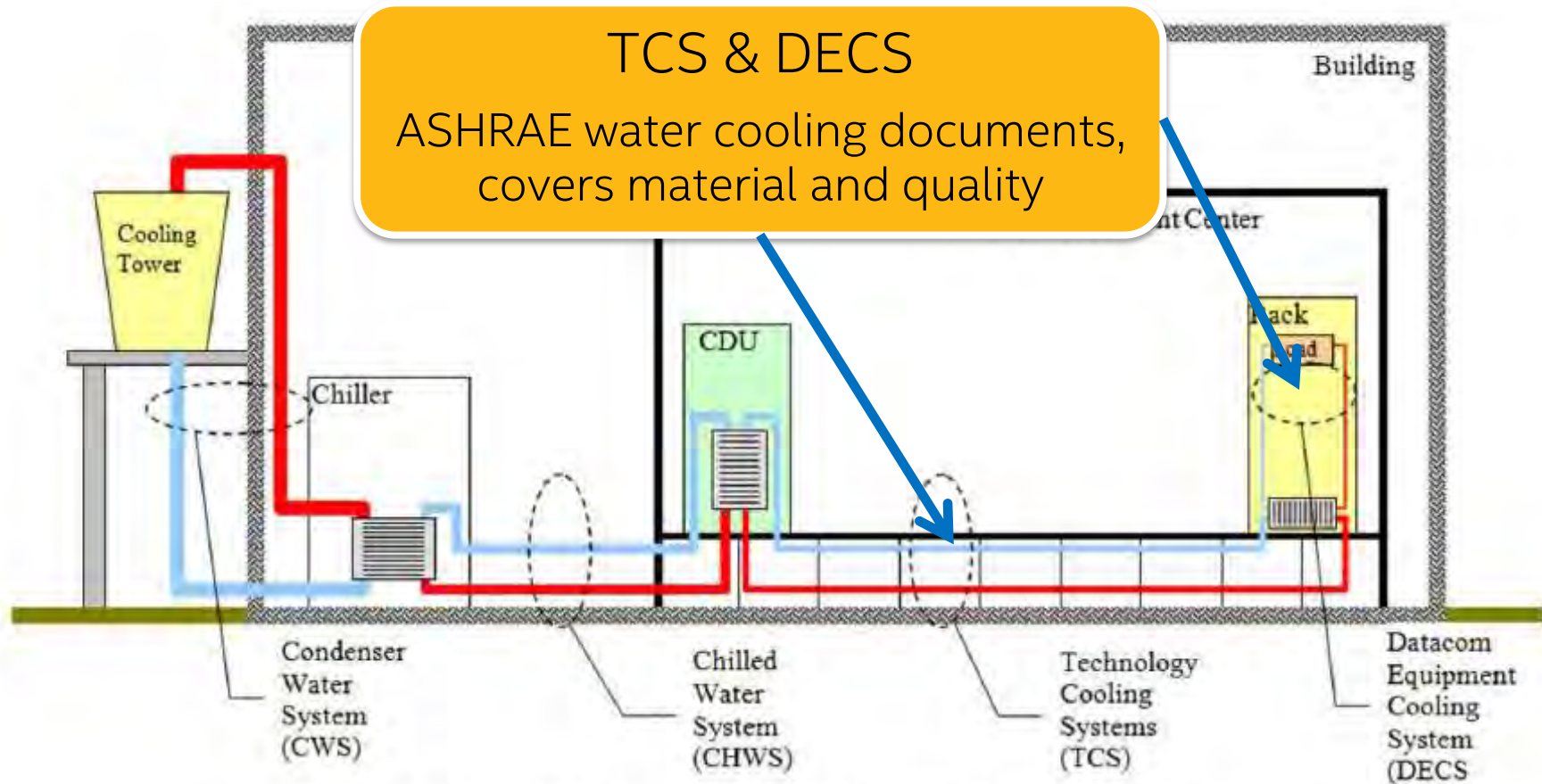

Figure 3: Liquid Cooling Systems / Loops within a Data Center

# Water Quality Problems

- Corrosion – chemical attack on materials of construction (e.g. chloride corrosion in stainless steel)
- Scaling – chemical formation of deposits in cooling systems (e.g. hardness scaling)
- Fouling – particulate or physical blocking of channels or coating of surfaces (e.g. construction debris or dirt/dust blocking  $\mu$ channels or plugging filters)
- Microbial – Biological activity in water systems (e.g. can lead to fouling or corrosion)
- System Design – material compatibility, dead legs, component selection

# Water Treatment

Deionized or demineralized water – chemical or electronic treatment exchanging  $H^+$  and  $OH^-$  ions for contaminants

Reverse osmosis – high pressure membranes rejecting many contaminants

Distillation – boiling and condensation to leave contaminants behind

Filtration – physical screening of contaminants

UV light – bacterial control

Anti-scalant – chemical treatment to reduce scaling potential

Corrosion inhibitor – chemical treatment to reduce corrosion

Biocide – chemical treatment to control microbes

Final spec and source water will dictate treatment needed

Don't guess; get expert advice!

# Things to know....

- Every water system is an on-going chemistry and biology experiment
- Closed loop systems need water quality monitoring, control, and maintenance
- In water systems; there is no such thing as “zero”  
– there is always some bacteria, minerals, dissolved solids, just at trace levels

Ignoring water quality and water treatment guarantees failure



# Resources

## ***ASHRAE***

### **TC 9.9 Committee**

<http://tc99.ashraetcs.org/>

### **Books**

<https://www.ashrae.org/resources--publications/bookstore/datacom-series>

## ***EE HPC WG***

<http://eehpcwg.lbl.gov/>

### **Hot for Warm Water Cooling**

<http://eetd.lbl.gov/sites/all/files/publications/lbnl-5128e.pdf>

### **Liquid Cooling Commissioning**

<https://docs.google.com/viewer?a=v&pid=sites&srcid=bGJsLmdvdnxlZWWhwY3dnfGd4OjlXNDljMzA1MmQ2ZjAzOTU>

## ***The Green Grid***

<http://www.thegreengrid.org/>

<http://www.thegreengrid.org/en/Global/Content/Tools/NAmericanFreeCoolingTool>

# Liquid Cooling Key Take-Aways

- Vertical Integration increasing; Understand system type and implications
  - Moving towards full liquid cooling and / or immersion based on density needs
  - Challenge is watts/m<sup>3</sup> as much as watts/cm<sup>2</sup>
- Mixed Temperature issues....
  - W3 and W4 for compute...but:
  - Cooler temps may be needed for comfort, dehumidification, I/O and Storage racks
- Loop temperature considerations
  - Condensation!
  - Specify water temperature at the facilities / IT loop heat exchanger inlet
- Water quality and maintenance is the #1 issue....
  - One may ignore this, but does so at one's own peril
- Help simplify life in the liquid-cooling community by
  - Define how close the liquid gets; in-row, rear-door, cold plate, immersion
  - Using ASHRAE designations; **W2, W3, W4**
  - Define facilities cooling loop; **chiller, cooling tower, dry cooler**
  - Just, please don't say "warm water cooling" 😊

Thanks for your attention. Questions?



